

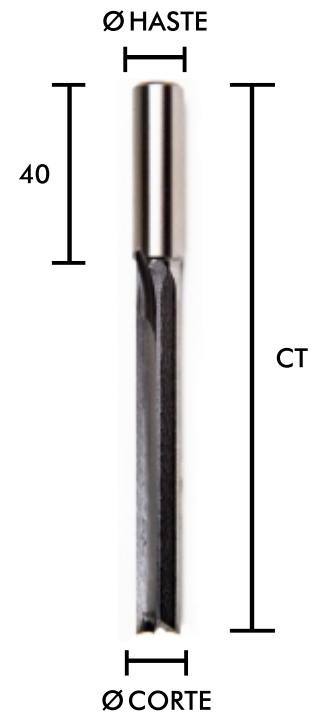

6000 BROCA COM DOIS CANAIS RETOS

CÓDIGO	UNID.	CT	Ø CORTE	Ø HASTE	C HASTE
6000.01	PC	125	6	12	40
6000.02	PC	125	8	12	40
6000.03	PC	125	10	12	40
6000.04	PC	125	12	12	40
6000.05	PC	125	15	16	40
6000.06	PC	125	16	16	40
6000.25	PC	125	18	16	40
6000.07	PC	125	20	16	40
6000.08	PC	125	25	16	40
6000.09	PC	125	30	16	40
6000.14	PC	150	10	12	40
6000.15	PC	150	12	12	40
6000.16	PC	150	15	16	40
6000.17	PC	150	16	16	40
6000.18	PC	150	17	16	40
6000.19	PC	150	20	16	40
6000.20	PC	150	25	16	40



6050 BROCA COM DOIS CANAIS HELICOIDAIS

CÓDIGO	UNID.	CT	Ø CORTE	Ø HASTE	C HASTE
6050.01	PC	125	6	12	40
6050.02	PC	125	8	12	40
6050.03	PC	125	10	12	40
6050.04	PC	125	12	12	40
6050.05	PC	125	15	16	40
6050.06	PC	125	16	16	40
6050.07	PC	125	20	16	40
6050.08	PC	125	25	16	40
6050.09	PC	125	30	16	40

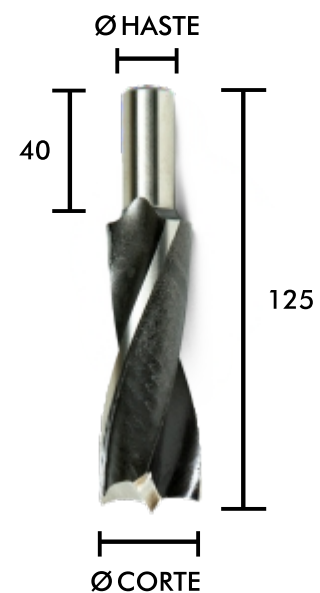



6100 BROCA COM QUATRO CANAIS RETOS

CÓDIGO	UNID.	CT	Ø CORTE	Ø HASTE	C HASTE
6100.01	PC	100	8	12	40
6100.02	PC	100	10	12	40
6100.03	PC	100	12	12	40
6100.04	PC	100	15	16	40
6100.05	PC	100	20	16	40

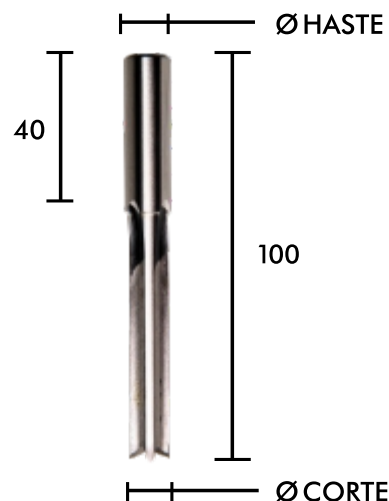

6150 BROCA TIPO RABO DE ANDORINHA

CÓDIGO	UNID.	CT	Ø CORTE	Ø HASTE
6150.01	PC	80	8	8
6150.02	PC	80	9	9
6150.03	PC	80	10	10
6150.05	PC	80	10	12
6150.04	PC	80	12	12

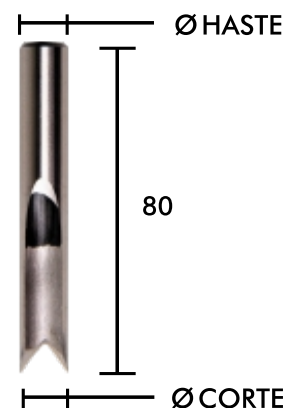

6160 BROCA PARA VENEZIANA

CÓDIGO	UNID.	CT	Ø CORTE	Ø HASTE
6160.05	PC	100	8	8
6160.06	PC	100	9	9
6160.07	PC	100	10	10
6160.08	PC	100	12	12
6160.21	PC	100	8	8
6160.22	PC	100	9	9
6160.23	PC	100	10	10
6160.24	PC	100	12	12

MODELO 1 (.05.06.07.08) **MODELO 3** (.21.22.23.24)

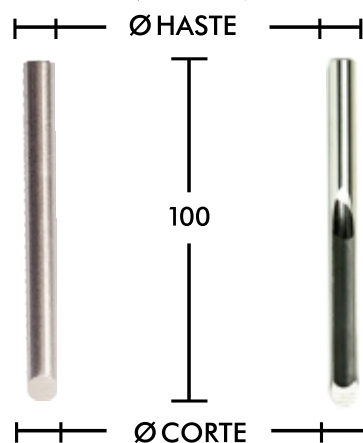



6200 BROCA PARA MALHETE

CÓDIGO	LADO	UNID.	CT	Ø CORTE	Ø HASTE
6200.01	D	PC	65	12,7	10
6200.02	E	PC	65	12,7	10

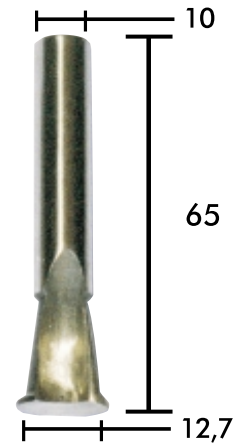

6300 BROCA PARA ALÇA DE CAIXA

CÓDIGO	UNID.	CT	Ø CORTE	Ø HASTE
6300.01	PC	145	28	16

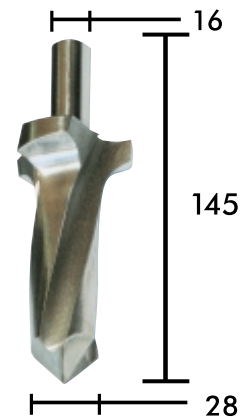

6350 BROCA PARA PINAR TABULETA

CÓDIGO	UNID.	Ø TARUGO	CABO
6350.01	PC	8	COM
6350.02	PC	9	COM
6350.03	PC	10	COM
6350.04	PC	12	COM
6350.05	PC	8	SEM
6350.06	PC	9	SEM
6350.07	PC	10	SEM
6350.08	PC	12	SEM

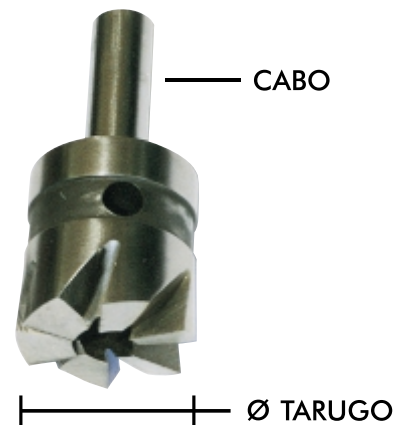



6500

BROCA PARA FURADEIRA MULTIPLA HW (NÃO PASSANTE)

CÓDIGO	UNID.	CT	Ø CORTE	Ø HASTE	ROTAÇÃO
6500.01	PC	57	5	10	D
6500.02	PC	57	5	10	E
6500.05	PC	57	6	10	D
6500.06	PC	57	6	10	E
6500.13	PC	57	8	10	D
6500.14	PC	57	8	10	E
6500.21	PC	57	10	10	D
6500.22	PC	57	10	10	E
6500.25	PC	57	12	10	D
6500.26	PC	57	12	10	E
6500.29	PC	57	15	10	D
6500.30	PC	57	15	10	E

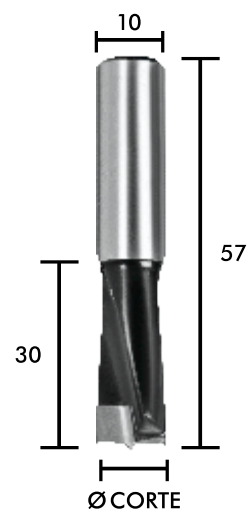

6800

BROCA PARA DOBRADIÇA HW

CÓDIGO	UNID.	CT	Ø CORTE	Ø HASTE	ROTAÇÃO
6800.07	PC	57	20	10	D
6800.03	PC	57	26	10	D
6800.05	PC	57	35	10	D



6960

ESCAREADOR HW (DOIS CORTES)

CÓDIGO	UNID.	Ø BROCA	Ø HASTE	TIPO
6960.01	PC	3,0	8	Cônico (45°)
6960.02	PC	3,5	8	Cônico (45°)
6960.03	PC	3,5	8	Reto
6960.04	PC	4,0	10	Cônico (45°)
6960.05	PC	4,0	10	Reto

